



**RT-RPU2400
CARBATEC VARIABLE SPEED
ROUTER POWER UNIT**

INSTRUCTIONS MANUAL

carbatec.com.au

carbatec®

1 YEAR
WARRANTY

THANK YOU FOR CHOOSING carbatec®

Carbatec has been a trusted brand for woodworking enthusiasts and professionals across Australia and New Zealand, since 1987.



Our quality woodworking products are designed and built to offer value and performance, making the latest features and technological advancements more accessible to Aussie woodworkers.

Backed by our no-fuss after-sales care and warranty support, you can trust Carbatec to keep you woodworking, as promised.

We look forward to sharing in your woodworking journey!

If you have any questions about our products or service, please call us on **1800 658 111** or email us at info@carbatec.com.au

Find us on social media

-  facebook.com/Carbatec
-  instagram.com/Carbatec
-  youtube.com/@CarbatecTheHomeOfWoodworking

WHAT'S IN THE BOX

The following items are provided
in the shipping box:



FIG. 1

RT-RPU2400 CARBATEC VARIABLE SPEED ROUTER POWER UNIT

- A. Main Body
- B. 1/4" Collet Nut
- C. 1/2" Collet Nut
- D. ER Lock Nut
- E. Collet Spanners (x2)

IMPORTANT

4

Key information can be found on the inspection panel, found on the rear of the machine.

carbatec
QUALITY INSPECTED

Model:
Voltage
Freq:
Phase:
Amp:
kW:
Speed:
Lot No.:
Serial No.:
Date:

Made in for:
CARBATEC PTY LTD
Brisbane - Australia



Record the serial number and date of purchase in your manual for future reference.

SERIAL NUMBER:

DATE OF PURCHASE:

CONTENTS

Introduction	2
What's in the box	3
Key information	4
Safety instructions - General	6-9
Safety instructions - Router Power Unit	10-11
Safety instructions - Electrical	12-13
Overview & Specifications	14
Assembly	15-19
Operation	20
Maintenance & Cleaning	21
Table Installation	23
Parts diagram	24
Parts list	25
Warranty details	27

NOTE: The specifications, photographs, drawings and information in this manual represent the current machine model when the manual was prepared. Changes and improvements may be made at any time, with no obligation on the part of Carbatec to modify previously delivered units. Reasonable care has been taken to ensure that the information in this manual is correct, to provide you with the guidelines for the proper safety, assembly and operation of this machine.

SAFETY INSTRUCTIONS

IMPORTANT! Safety is the single most important consideration in the operation of this equipment. The following instructions must be followed at all times. Failure to follow all instructions listed below may result in electric shock, fire, and/or serious personal injury. There are certain applications for which this tool was designed. We strongly recommend that this tool not be modified and/or used for any other application other than that for which it was designed. If you have any questions about its application, do not use the tool until you have contacted us and we have advised you.

The purpose of safety symbols is to attract your attention to possible dangers. The safety symbols and the explanations with them deserve your careful attention and understanding. The symbol warnings do not, by themselves, eliminate any danger. The instructions and warnings they give are no substitutes for proper accident prevention measures.



WARNING

Be sure to read and understand all safety instructions in this manual, including all safety alert symbols such as "DANGER," "WARNING," and "CAUTION" before using this tool. Failure to following all instructions listed below may result in electric shock, fire, and/or serious personal injury.

6

SYMBOL MEANING



A safety alert symbol Indicates **DANGER, WARNING, or CAUTION.** May be used in conjunction with other symbols or pictographs.



DANGER

Indicates an imminently hazardous situation, which, if not avoided, will result in death or serious injury.



WARNING

Indicates a potentially hazardous situation, which, if not avoided, could result in death or serious injury.



CAUTION

Indicates a potentially hazardous situation, which, if not avoided, could result in minor or moderate injury.

NOTICE

(Without Safety Alert Symbol) Indicates a situation that may result in property damage.



Carbatec products bearing the Regulatory Compliance Mark (RCM) have been tested in accordance with applicable Australian/New Zealand Standards to ensure their compliance with all mandatory standards and regulations (applicable at time of original sale). Carbatec Pty Ltd are registered as a responsible supplier with relevant Australian government departments and our products are registered on the EESS & ACMA database.

GENERAL SAFETY

Operating a power tool can be dangerous if safety and common sense are ignored. The operator must be familiar with the operation of this machine. Read this manual to understand this machine. **DO NOT OPERATE** this machine **IF YOU DO NOT FULLY UNDERSTAND** the limitations of this tool. **DO NOT MODIFY** this machine in any way.

BEFORE USING THIS MACHINE



WARNING

To avoid serious injury and damage to the tool, read and follow all of the Safety and Operating Instructions before operating the machine.



WARNING

- SOME DUST CREATED BY USING POWER TOOLS CONTAINS CHEMICALS** known to cause cancer, birth defects, or other reproductive harm. Some examples of these chemicals are:
 - Lead from lead-based paints.
 - Crystalline silica from bricks, cement, and other masonry products.
 - Arsenic and chromium from chemically treated lumber

Your risk from these exposures varies, depending on how often you do this type of work. To reduce your exposure to these chemicals: work in a well ventilated area and work with approved safety equipment, such as those dust masks that are specially designed to filter out microscopic particles.

- 2. READ** this entire manual. **LEARN** how to use the tool for its intended applications.
- 3. GROUND ALL TOOLS.** If the tool is supplied with a 3-prong plug, it must be plugged into a 3-contact electrical receptacle. The third prong is used to ground the tool and provide protection against accidental electric shock.
- 4. AVOID A DANGEROUS WORKING ENVIRONMENT.** Do not use electrical tools in a damp environment or expose them to rain.
- 5. DO NOT USE** electrical tools in the presence of **FLAMMABLE** liquids or gases.
- 6. ALWAYS KEEP THE AREA CLEAN,** well lit, and organized. Do not work in an environment with floor surfaces that are slippery from debris, grease, and wax.
- 7. KEEP VISITORS AND CHILDREN AWAY.** Do not permit people to be in the immediate work area, especially when the electrical tool is operating.
- 8. DO NOT FORCE THE TOOL** to perform an operation for which it was not designed. It will do a safer and higher quality job by only performing operations for which the tool was intended.
- 9. WEAR PROPER CLOTHING.** Do not wear loose clothing, gloves, neckties, or jewellery. These items can get caught in the machine during operations and pull the operator into the moving parts. The user must wear a protective cover on their hair, if hair is long, to prevent it from contacting any moving parts.

GENERAL SAFETY

- 10. CHILDPROOF THE WORKSHOP AREA** by removing switch keys, unplugging tools from the electrical receptacles, and using padlocks.
- 11. ALWAYS UNPLUG THE TOOL FROM THE ELECTRICAL RECEPTACLE** when making adjustments, changing parts or performing any maintenance.
- 12. KEEP PROTECTIVE GUARDS IN PLACE AND IN WORKING ORDER.**
- 13. AVOID ACCIDENTAL STARTING.** Make sure that the power switch is in the "OFF" position before plugging in the power cord to the electrical receptacle.
- 14. REMOVE ALL MAINTENANCE TOOLS** from the immediate area prior to turning "ON" the machine.
- 15. USE ONLY RECOMMENDED ACCESSORIES.** Use of incorrect or improper accessories could cause serious injury to the operator and cause damage to the tool. If in doubt, check the instruction manual that comes with that particular accessory.
- 16. NEVER LEAVE A RUNNING TOOL UNATTENDED.** Turn the power switch to the "OFF" position. Do not leave the tool until it has come to a complete stop.
- 17. DO NOT STAND ON A TOOL.** Serious injury could result if the tool tips over, or you accidentally contact the tool.
- 18. DO NOT STORE ANYTHING ABOVE OR NEAR** the tool where anyone might try to stand on the tool to reach it.
- 19. MAINTAIN YOUR BALANCE.** Do not extend yourself over the tool. Wear oil resistant rubber soled shoes. Keep floor clear of debris, grease, and wax.
- 20. MAINTAIN TOOLS WITH CARE.** Always keep tools clean and in good working order. Keep all blades and tool bits sharp, dress grinding wheels and change other abrasive accessories when worn.
- 21. EACH AND EVERY TIME, CHECK FOR DAMAGED PARTS PRIOR TO USING THE TOOL.** Carefully check all guards to see that they operate properly, are not damaged, and perform their intended functions. Check for alignment, binding or breaking of moving parts. A guard or other part that is damaged should be immediately repaired or replaced.
- 22. DO NOT OPERATE TOOL WHILE TIRED, OR UNDER THE INFLUENCE OF DRUGS, MEDICATION OR ALCOHOL.**

- 23. SECURE ALL WORK.** Use clamps or jigs to secure the work piece. This is safer than attempting to hold the work piece with your hands.
- 24. STAY ALERT, WATCH WHAT YOU ARE DOING, AND USE COMMON SENSE WHEN OPERATING A POWER TOOL.** A moment of inattention while operating power tools may result in serious personal injury.
- 25. ALWAYS WEAR A DUST MASK TO PREVENT INHALING DANGEROUS DUST OR AIRBORNE PARTICLES,** including wood dust, crystalline silica dust and asbestos dust. Direct particles away from face and body. Always operate tool in well ventilated area and provide for proper dust removal. Use dust collection system wherever possible. Exposure to dust may cause serious and permanent respiratory or other injury, including silicosis (a serious lung disease), cancer, and death. Avoid breathing dust, and avoid prolonged contact with dust. Allowing dust to get into your mouth or eyes, or lay on your skin may promote absorption of harmful material. Always use properly fitting AS/NZS approved respiratory protection appropriate for the dust exposure, and wash exposed areas with soap and water.
- 26. USE A PROPER EXTENSION CORD IN GOOD CONDITION.** Use of extension cords should be avoided where possible. When using an extension cord, be sure to have a cord heavy enough to carry the current your product will draw, and with compatible pin configuration and connections (NEVER use an extension cord rated at less than your machine). Longer run extensions will need heavier duty extension cords. Only connect your extension cord or machine to a receptacle that accepts your plug and never modify your plug to suit a receptacle.

SPECIFIC ROUTER SAFETY



WARNING

Some dust created by power sanding, sawing, grinding, drilling and other construction activities contains chemicals known to cause cancer, birth defects or other reproductive harm.

SOME EXAMPLES OF THESE CHEMICALS ARE:

- Lead from lead-based paint
- Crystalline silica from bricks and cement and other masonry products, and arsenic and chromium from chemically-treated lumber.

Your risk from these exposures varies, depending on how often you do this type of work. To reduce your exposure to these chemicals: work in a well-ventilated area, and work with approved safety equipment, such as those dust masks that are specifically designed to filter out microscopic particles.

- Disconnect the power supply before making any adjustments or changing bits. Inspect bits carefully before installing
- Read, understand, and follow the instructions packaged with the router table and router lift. Do not plug in remote power until the router table motor is fully installed.
- Always make sure the work piece is free from nails, screws, and other foreign objects.
- Never start the tool when the bit is in contact with the material. The bit cutting edge may grab the material causing loss of control of the work piece.
- Never place hands near the moving cutter
- Never touch the bit during or immediately after use. After use the bit may be hot enough to burn bare skin.
- Never use dull or damaged bits and sharp bits must be handled with care.
 - Dull bits require more force, which could cause the bit to break.
 - Damaged bits can throw carbide pieces and burn the work piece.
- Wear safety glasses or goggles, or a face shield (with safety glasses or goggles) and appropriate hearing protection.
- Ensure that the bit is securely mounted in the chuck and the router power unit is tightly clamped in the router lift
- Make sure that the bit can rotate freely before reconnecting and switching on the power.
- Keep all cords clear of cutting area.
- To reduce the risk of injury, avoid "climb cutting." Climb cutting can cause the work piece to be thrown violently out of your control. Even small router bits can result in climb cutting. Always feed the work piece against the cutter rotation.

Also, do not 'back up' the stock during a cut. This can also result in unexpected 'kickback'.

- After changing the bit or making any adjustments, make sure the collet nut and any other adjustment devices are securely tightened. Loose adjustment devices can unexpectedly shift, causing loss of control. Loose rotating components will be violently thrown. Watch for vibration or wobbling that could indicate an improperly installed bit.
- Use the cutter (and spindle speed / RPM) suited for the job and bit installed.
- Remove all wrenches and tools used in the set up from the table.
- Make sure all guards are in proper position
- Use jig fixtures, holders, and hold-down push blocks. Fasten the work securely in a jig. When a table guide pin is used, make sure it is adjusted and will not slip.
- Use extra care in machining stock that contains cross grains or knots. These may pull the operator's hands into the knives or may cause kickbacks.
- Do not leave a shaper machine running. Make sure that the power is shut off and that the cutter head has stopped revolving before leaving the area.
- Do not make deep cuts or feed the stock too rapidly.
- Do not cut stock that has loose knots, splits, defects or foreign objects (e.g., metal, stone) in it.
- Do not distract or startle an operator during a shaping operation.
- Do not remove saw dust or cuttings around knives by hand or with compressed air. Use a stick or brush.
- Do not clear the table while the cutter is rotating.
- Do not accumulate stock or finished work on the table.
- Do not stand in line with the stock being fed.
- Do not wear loose clothing, work gloves, neckties, rings, bracelets or other jewellery that can become entangled with moving parts.
- Use only specifically recommended accessories. Others may be hazardous.

ELECTRICAL SAFETY

WARNING

This tool must be grounded while in use to protect the operator from electric shock. IN THE EVENT OF A MALFUNCTION OR BREAKDOWN, grounding provides the path of least resistance for electric current and reduces the risk of electric shock. This tool may be equipped with an electric cord that has an equipment grounding conductor and a grounding plug. **The plug MUST Be plugged** into a matching electrical receptacle that is properly installed and grounded in accordance with **ALL** local codes and ordinances.

- **DO NOT MODIFY THE PLUG PROVIDED.** If it will not fit the electrical receptacle, have the proper electrical receptacle installed by a qualified electrician.

IMPROPER ELECTRICAL CONNECTION of the equipment grounding conductor can result in risk of electric shock. The conductor with the green insulation (with or without yellow stripes) is the equipment grounding conductor. **DO NOT** connect the equipment grounding conductor to a live terminal if repair or replacement of the electric cord or plug is necessary.

CHECK WITH A QUALIFIED ELECTRICIAN

or service personnel if you do not completely understand the grounding instructions, or if you are not sure the tool is properly grounded.

Use only a 3-wire extension cord that has a 3-prong grounding plug and a 3-pole receptacle that accepts the tool's plug. Replace a damaged or worn cord immediately.

Power tools and machinery are intended for use on a circuit that has an electrical receptacle as shown in **FIGURE A** that shows a 10 Amp 3-wire electrical plug and corresponding electrical receptacle that has a grounding conductor.

If this particular tool has been designed and fitted with a two prong electrical plug, ensure it displays the 'Double Insulated' logo shown in **FIGURE B**, before connecting to a 3-wire receptacle.

WARNING

Never modify the standard fitted electrical plugs to fit your receptacle.



OVERLOAD PROTECTION

Before the motor is overloaded, the electronic overload protection circuit will turn off the tool.

SOFT START

The Soft-Start feature reduces the amount of torque reaction of the tool. This feature gradually increases the motor speed up from zero to the speed set by the variable speed dial.

FEEDBACK CONTROL

The electronic speed control system allows the tool to maintain constant speed between no-load and load conditions.

WARNING

To reduce the risk of injury, always use feather boards, push sticks or push blocks with proper guarding. Keep hands away from moving bit. Refer to the Router Table manual for proper table setup and use.

CUTTING

The speed and depth of cut will depend largely on the type of material being used. Keep the cutting pressure constant but do not use excessive force so the motor speed slows excessively. It may be necessary on exceptionally hard woods or problem materials to make more than one pass to get the desired depth of cut.

Before beginning the cut on the actual work piece, it is advisable to take a sample cut on a scrap piece of lumber. This will show you exactly how the cut will look as well as enable you to check dimensions. Position the fence so that the work piece feeds against the cutter rotation.

WARNING

To reduce the risk of injury, avoid "climb cutting." Climb cutting can cause the work piece to be thrown violently out of your control. Even small router bits can cause in climb cutting.

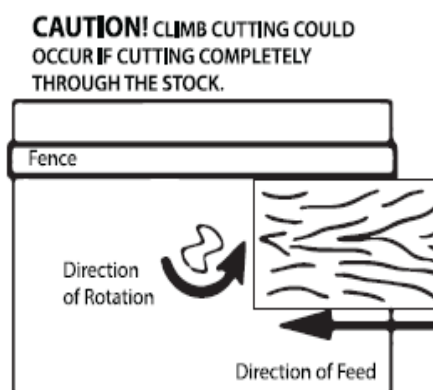
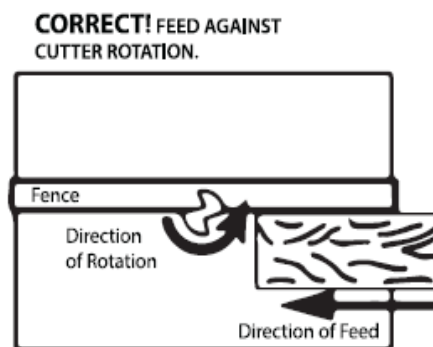
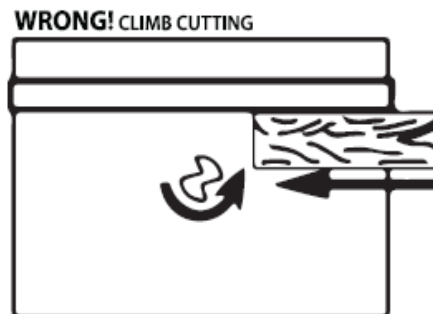

OVERVIEW

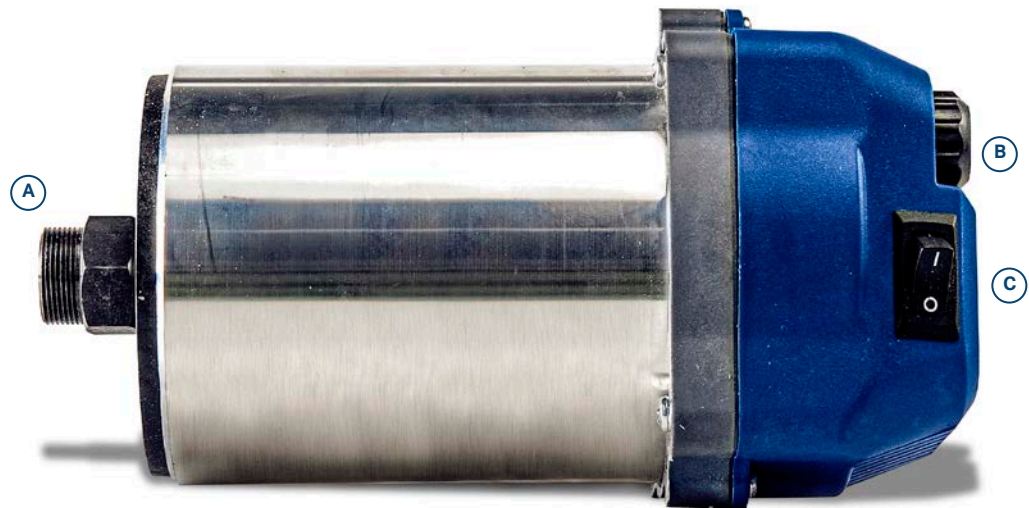

FIG. 2

ROUTER MOTOR OVERVIEW

Fig. 2

A. Collet Chuck

B. Speed Control

C. ON/OFF Switch

SPECIFICATIONS

VOLTS AC	230 V~50 Hz
HORSEPOWER	2400 W (input) 1800 W (output)
NO LOAD RPM	10,000 – 22,000

ASSEMBLY

FIG. 3



WARNING

To reduce the risk of injury, always unplug the tool before attaching or removing accessories or making adjustments. Use only specifically recommended accessories. Others may be hazardous.

COLLETS & NUTS

The collet must be attached to the collet nut before it is put into the collet chuck. Be sure that the size of the collet matches the size of the bit shank being used. If the wrong size bit shank is used, the collet may break.

FIG. 4



ATTACHING COLLET TO COLLET NUT:

Fig. 3 & 4

This product includes:

- 1/4" collet x 1
- 1/2" collet x 1
- ER lock nut x 1

Each collet and nut threads onto the collet chuck with a standard right hand thread.

NOTICE

Do not tighten the collet and the nut without a bit inserted to avoid damage.

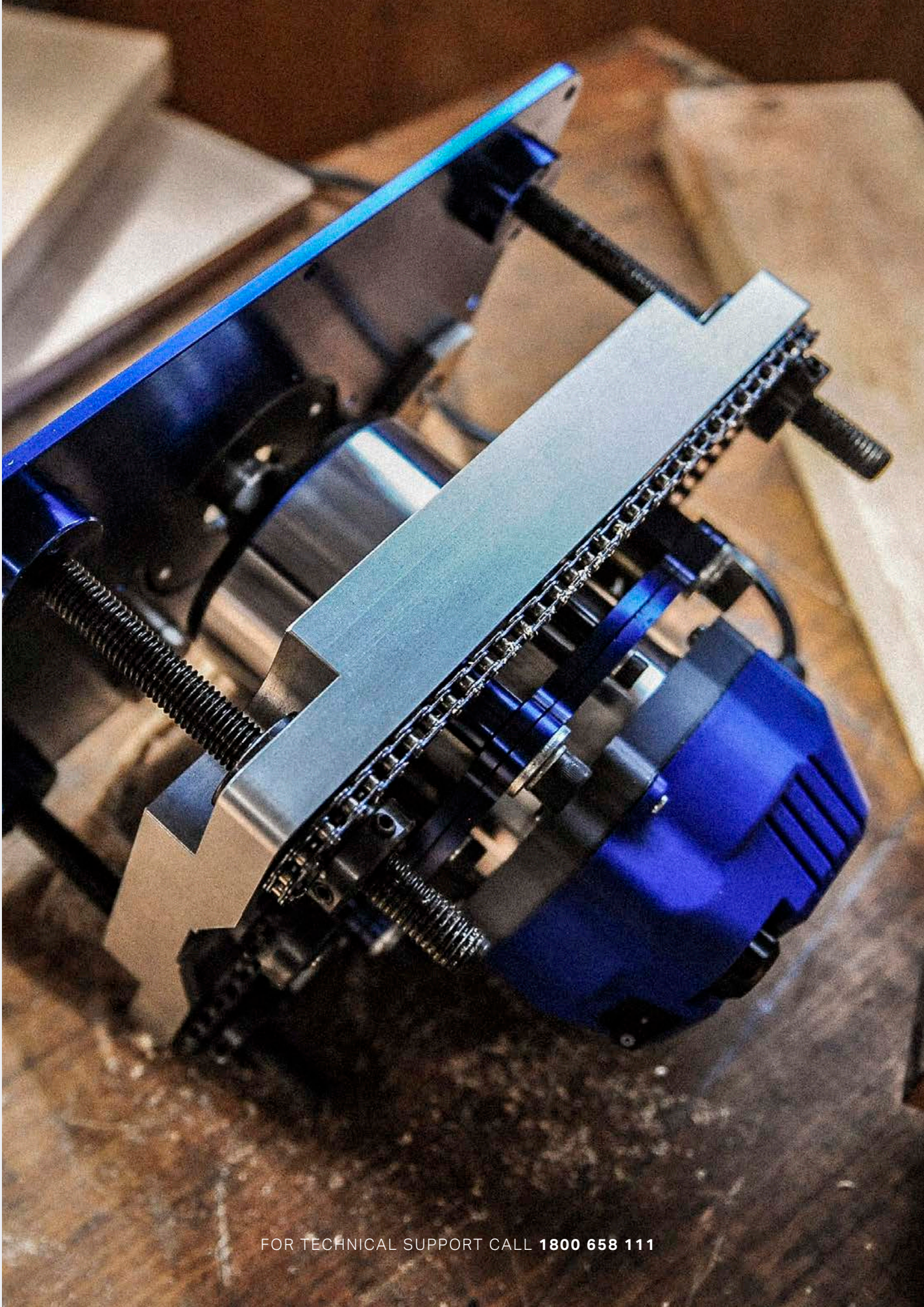

ASSEMBLY

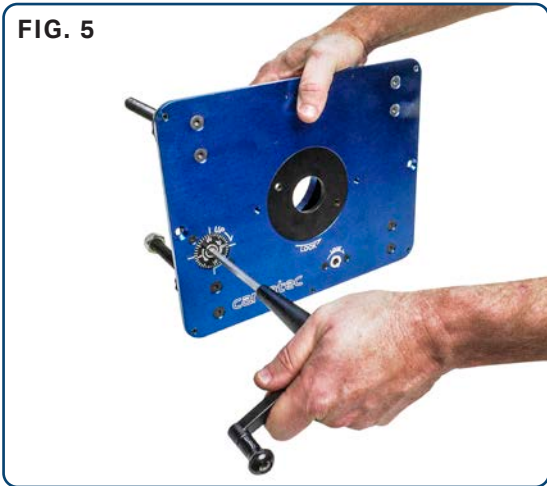

INSTALLING THE ROUTER MOTOR INTO A TABLE LIFT

Fig. 5-7

The router power unit must be clamped into an appropriate router lift or other mounting device before use.

⚠ WARNING

Do not attempt to use the router power unit hand held



1. Wind the router lift to its minimum height. (Fig. 5)
2. Loosen the router clamp and insert the router power unit into the lift till the housing touches the bottom of the lift plate. (Fig. 6)
3. Firmly clamp the router power unit into the lift and check for a tight fit. (Fig. 7)

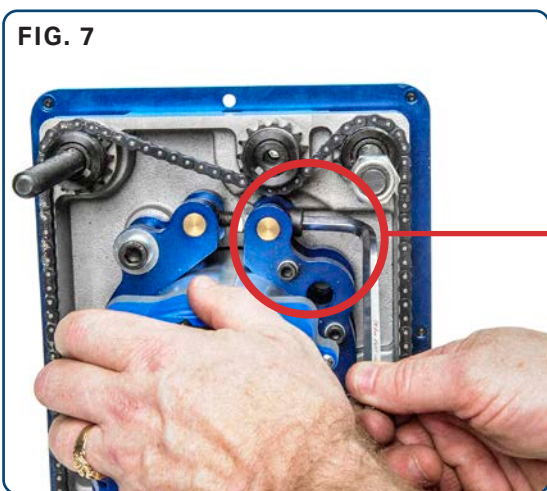

ASSEMBLY

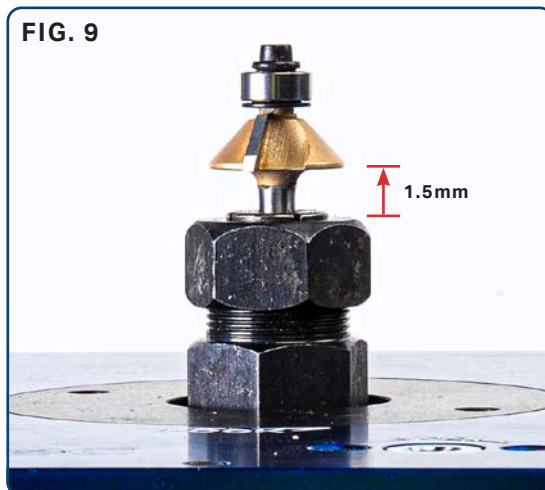
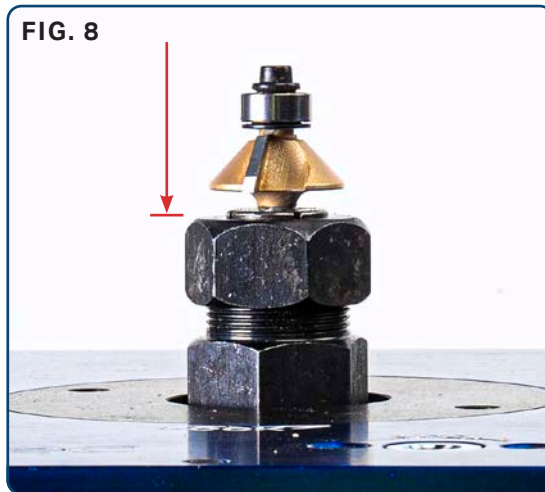

INSTALLING THE BIT

Fig. 8-10

NOTICE

If the router power unit is mounted in a router lift, it is not necessary to remove the motor from the lift to install a collet assembly or a bit

Disconnect power and raise the motor as high as possible. Always wipe wood chips, dust, or other foreign materials from the collet shaft and collet assembly before assembling.

INSERTING THE COLLET ASSEMBLY INTO THE COLLET SHAFT.

1. Insert the bit shank into the collet as far as it will go. (Fig. 8)
2. Back the bit shank out slightly to avoid bottoming out. Be sure there is a minimum of 1.5 mm between the bottom of the collet assembly and the radius to the cutting portion of the bit. (Fig. 9)
3. To tighten the bit in the collet assembly use two wrenches in the direction shown. (Fig. 10)

NOTICE

Never tighten a collet assembly without inserting a bit shank of the proper size. This may damage the collet.



REMOVING THE BIT

Fig. 11-12

1. Loosen the collet nut from the collet shaft using two wrenches in the direction shown. (Fig. 11)
2. Once loose, unscrew the collet nut by hand until it feels tight again.
3. Return to using the wrenches until the bit shank can be pulled out. (Fig. 12)

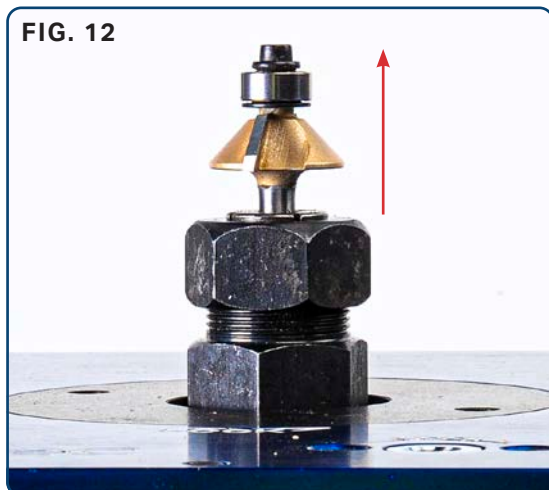

OPERATION

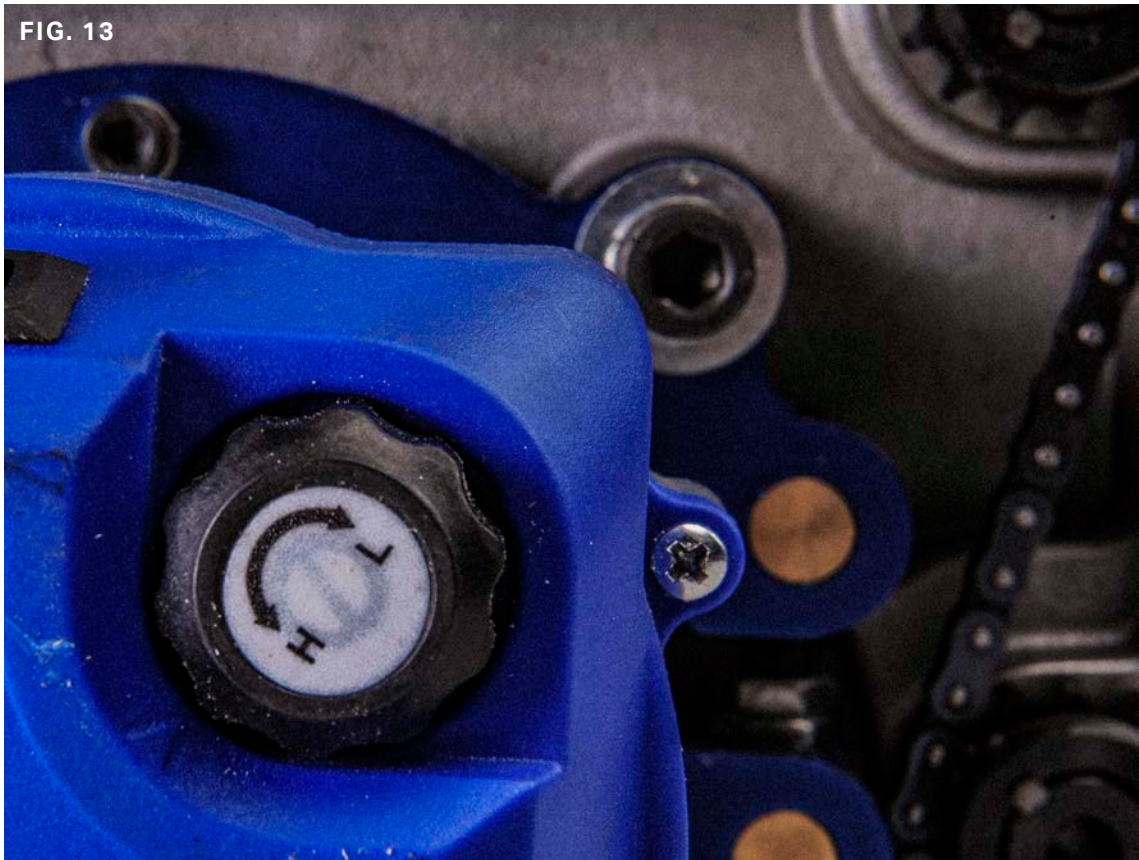

FIG. 13

20

VARIABLE SPEED DIAL

Fig. 13

The variable speed dial allows you to adjust the rotating speed Revolutions Per Minute (RPM) of the tool.

Use the following chart to determine the best speed for the bit diameter.

SPEED SETTING	RPM	MAX. BIT DIAMETER
Slow	10,000	3" to 3-1/2"
	12,000	
Medium	14,000	2-1/4" to 2-1/2"
	16,000	
Medium	18,000	1-1/4" to 2"
Fast	20,000	1"
Fast	22,000	<1"

MAINTENANCE & CLEANING

WARNING

To reduce the risk of injury, always unplug your tool before performing any maintenance. Never disassemble the tool or try to do any rewiring on the tool's electrical system.

TOOL MAINTENANCE

Keep your tool in good repair by adopting a regular maintenance program. Before use, examine the general condition of your tool. Inspect guards, switches, power cords and extension cord for damage. Check for loose screws, misalignment, binding of moving parts, improper mounting, broken parts and any other condition that may affect its safe operation. If abnormal noise or vibration occurs, turn the tool off immediately and have the problem corrected before further use. Do not use a damaged tool.

WARNING

To reduce the risk of injury, electric shock and damage to the tool, never immerse your tool in liquid or allow a liquid to flow inside the tool.

CLEANING YOUR TOOL

Clean dust and debris from vents. Keep the tool handles clean, dry and free of oil or grease. Use only mild soap and a damp cloth to clean your tool. Never use cleaning agents and solvents such as: gasoline, turpentine, lacquer thinner, paint thinner, chlorinated cleaning solvents, ammonia, household detergents containing ammonia, flammable or combustible solvents around tools. These are harmful to your tool, plastics and insulated parts.



TABLE INSTALLATION

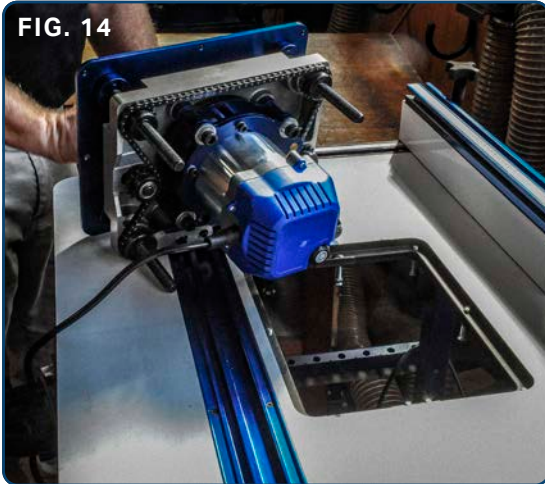

INSTALLING THE LIFT INTO A ROUTER TABLE

Fig. 14-16

The router power unit must be clamped into an appropriate router lift or other mounting device.

1. With the router power unit firmly mounted in the lift, place the power cord through the hole in the table. (Fig. 14)
2. Lower the lift into the table and use the table insert levelers to adjust the fit for perfect alignment.
3. Attach the lift to the table with the retaining screws. (Fig. 15)
4. Remove the lift infill with a spanner, to give access to the collet nuts. (Fig. 16)



PARTS DIAGRAM

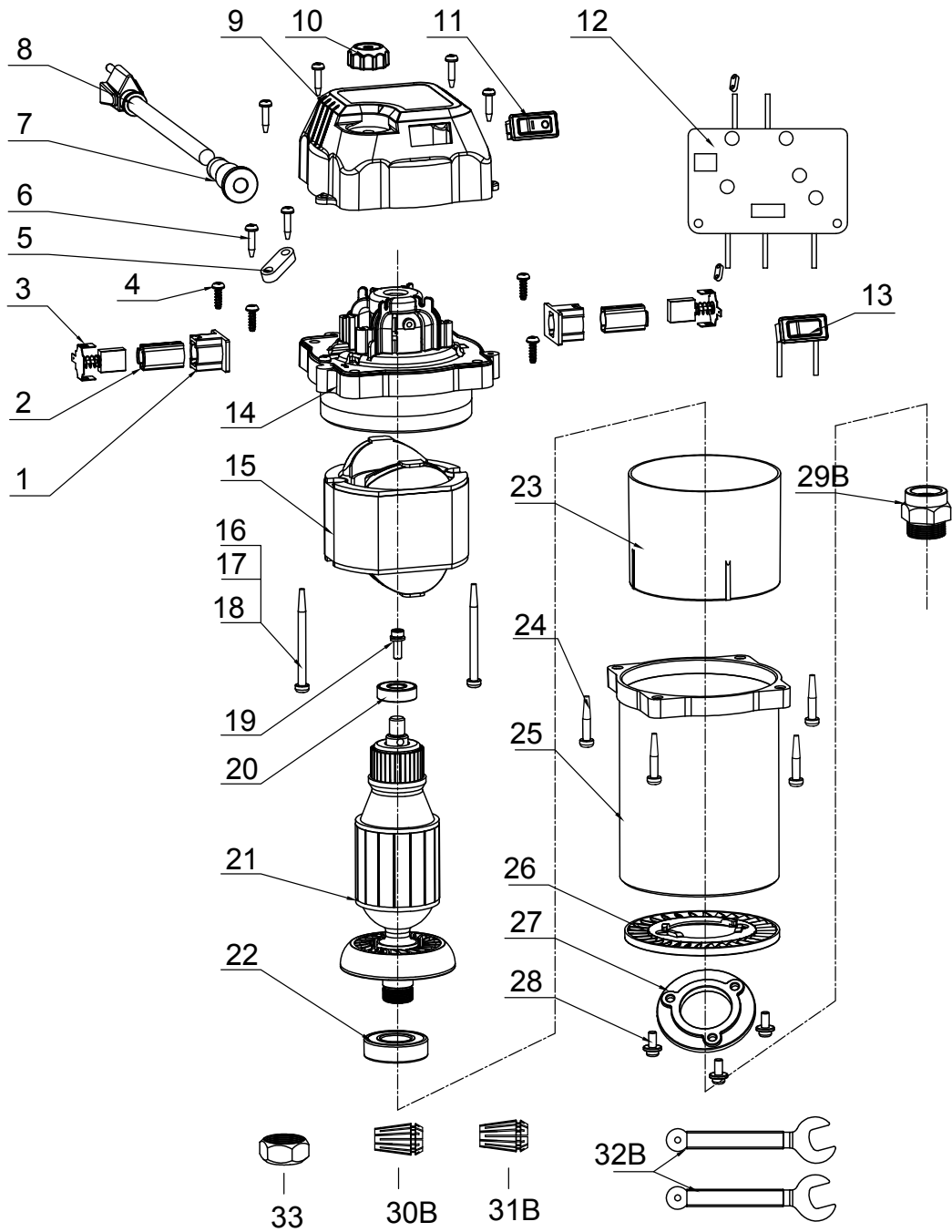

PARTS LIST

PART ID	PRODUCT CODE	PART NAME	QUANTITY
1	RT-RPU2400-001	Brush Box	2
2	RT-RPU2400-002	Brush Shell	2
3	RT-RPU2400-003	Carbon Brush	2
4	RT-RPU2400-004	Tapping Screw	4
5	RT-RPU2400-005	Strain Relief	1
6	RT-RPU2400-006	Tapping Screw	6
7	RT-RPU2400-007	Wire Bushing	1
8	RT-RPU2400-008	Power Cord	1
9	RT-RPU2400-009	Motor Rear Cover	1
10	RT-RPU2400-010	Adjustment Knob	1
11	RT-RPU2400-011	Power Switch	1
12	RT-RPU2400-012	PCB Board	1
13	RT-RPU2400-013	Capacitor	1
14	RT-RPU2400-014	Stator Housing	1
15	RT-RPU2400-015	Motor Stator	1
16	RT-RPU2400-016	Pan Head Screw	2
17	RT-RPU2400-017	Flat Washer	2
18	RT-RPU2400-018	Spring Washer	2
19	RT-RPU2400-019	Magnet Components	1
20	RT-RPU2400-020	Bearing	1
21	RT-RPU2400-021	Motor Rotor	1
22	RT-RPU2400-022	Bearing	1
23	RT-RPU2400-023	Wind Deflector	1
24	RT-RPU2400-024	Head Cap Screw	4
25	RT-RPU2400-025	Router Housing	1
26	RT-RPU2400-026	Dust Board	1
27	RT-RPU2400-027	Bearing Press Plate	1
28	RT-RPU2400-028	Countersunk Head Screw	3
29B	RT-RPU2400-029B	Exchange Bolt	1
30B	RT-RPU2400-030B	¼" Collet	1
31B	RT-RPU2400-031B	½" Collet	1
32B	RT-RPU2400-032B	Wrench	2
33	RT-RPU2400-033	ER Lock Nut	1



WARRANTY



WARRANTY

- A. We warrant that this Carbatec product will be free from defects caused by faulty workmanship or faulty materials for a period of 1 year from date of sale.
- B. This warranty is in addition to other rights and remedies you may have under a law in relation to the goods.
- C. This warranty does not apply in any of the following cases:
- i. Defects arising from:
 1. fair wear and tear;
 2. corrosive atmosphere;
 3. damage or injury caused by deliberate act, lack of care or failure to comply with the recommended care and maintenance for the goods;
 4. improper use of the goods;
 5. alterations or repairs (not made by us) to the goods;
 - ii. defects arising from an event outside of our control such as fire, flood, earthquake or other natural calamity, motor vehicle or other accident, strike, civil unrest, terrorism or war;
 - iii. to accessory items such as after-market jigs, accessories or other items which are not sold or serviced by us and which are not sold with or were not included with the main unit purchased; or
 - iv. to wearable parts such as drive belts/shafts, bearings, bandsaw tyres, motor brushes, blades or abrasive belts/discs or other cutting or machining implements.
 - v. damage caused to any electrical component, where connected to a power supply outside the country for which it was designed (namely Australia or New Zealand).
- D. If this warranty applies and you have complied with the procedure below for making a claim, we will, at our election, either repair the goods (or those parts of the goods recognised as defective) or will provide a replacement within a reasonable time at our expense.
- E. If this warranty applies, the procedure for making a claim is:
- i. you must contact us by email;
 - ii. you must include in the email the following information:
 1. a copy of the order or receipt for the goods;
 2. the serial or batch number printed on the machinery manufacturing plate; and
 3. a detailed description of the fault and how and when it arose; and
 - iii. If the fault is a type covered by this warranty, we will then make arrangements with you for the return of the goods to us (for repair or replacement) at our cost using our transport providers or we may decide to attend at your premises to repair or replace the goods.
- F. Our liability (and that of our resellers) under this warranty is wholly limited to repair or replacement of the goods (or those parts of the goods recognised as defective) in accordance with the procedure above and you have no right to other compensation, costs or damages under this warranty. But this does not mean that you may not have other rights under a law in relation to the goods.
- G. If following our inspection of goods returned by you under this warranty it is found that this warranty does not apply and you are not otherwise entitled to repair or replacement by us, you must, if requested by us, reimburse our costs including parts, labour and freight.
- H. This warranty is not transferable and only the person who purchased the goods may make a claim.
- I. Where the goods have been exported outside Australia or New Zealand, the Company may not require the Purchaser to return any allegedly faulty or defective Product for evaluation. However, the Company has the right to request the return for evaluation at purchasers cost.

STATUTORY NOTICE

Our goods come with guarantees that cannot be excluded under the Australian Consumer Law. You are entitled to a replacement or refund for a major failure and for compensation for any other reasonably foreseeable loss or damage. You are also entitled to have the goods repaired or replaced if the goods fail to be of acceptable quality and the failure does not amount to a major failure.



Carbatec Pty Ltd

E info@carbatec.com.au

AU: 1800 658 111

NZ: 0800 444 329

1/364 New Cleveland Rd, Tingalpa
QLD 4173, Australia

ABN 84 010 706 242

carbatec.com.au

carbatec®

1 YEAR
WARRANTY